



# NEC's 1/2W LOW VOLTAGE L, S-BAND SPDT SWITCH

## UPG2214TB

### FEATURES

- **SWITCH CONTROL VOLTAGE:**  
 $V_{cont(H)} = 1.8$  to  $5.3$  V (3.0 V TYP.)  
 $V_{cont(L)} = -0.2$  to  $+0.2$  V (0 V TYP.)
- **LOW INSERTION LOSS:**  
 $0.25$  dB TYP. @ 0.05 to 0.5 GHz,  $V_{cont(H)} = 3.0$  V,  $V_{cont(L)} = 0$  V  
 $0.25$  dB TYP. @ 0.5 to 1.0 GHz,  $V_{cont(H)} = 3.0$  V,  $V_{cont(L)} = 0$  V  
 $0.30$  dB TYP. @ 1.0 to 2.0 GHz,  $V_{cont(H)} = 3.0$  V,  $V_{cont(L)} = 0$  V  
 $0.35$  dB TYP. @ 2.0 to 2.5 GHz,  $V_{cont(H)} = 3.0$  V,  $V_{cont(L)} = 0$  V  
 $0.35$  dB TYP. @ 2.5 to 3.0 GHz,  $V_{cont(H)} = 3.0$  V,  $V_{cont(L)} = 0$  V
- **HIGH ISOLATION:**  
 $32$  dB TYP. @ 0.05 to 0.5 GHz,  $V_{cont(H)} = 3.0$  V,  $V_{cont(L)} = 0$  V  
 $28$  dB TYP. @ 0.5 to 1.0 GHz,  $V_{cont(H)} = 3.0$  V,  $V_{cont(L)} = 0$  V  
 $27$  dB TYP. @ 1.0 to 2.0 GHz,  $V_{cont(H)} = 3.0$  V,  $V_{cont(L)} = 0$  V  
 $26$  dB TYP. @ 2.0 to 2.5 GHz,  $V_{cont(H)} = 3.0$  V,  $V_{cont(L)} = 0$  V  
 $24$  dB TYP. @ 2.5 to 3.0 GHz,  $V_{cont(H)} = 3.0$  V,  $V_{cont(L)} = 0$  V
- **POWER HANDLING:**  
 $P_{in(1dB)} = +27.0$  dBm TYP. @ 0.5 to 3.0 GHz,  $V_{cont(H)} = 3.0$  V,  $V_{cont(L)} = 0$  V  
 $P_{in(1dB)} = +20.0$  dBm TYP. @ 0.5 to 3.0 GHz,  $V_{cont(H)} = 1.8$  V,  $V_{cont(L)} = 0$  V
- **HIGH-DENSITY SURFACE MOUNTING:**  
 6-pin super minimold package ( $2.0 \times 1.25 \times 0.9$  mm)
- **Pb FREE**

### DESCRIPTION

NEC's UPG2214TB is a GaAs MMIC L, S-band SPDT (Single Pole Double Throw) switch for mobile phones and other L, S-band applications from 0.05 to 3.0 GHz.

This device can operate from 1.8 to 5.3 V with low insertion loss and high isolation. Performance is specified at both 1.8 V and 3.0 V.

The UPG2214TB is housed in a 6-pin super minimold package suitable for high-density surface mounting.

### APPLICATIONS

- **L, S-band digital cellular and cordless telephones**
- **Bluetooth™, W-LAN, and WLL**
- **Short Range Wireless**

### ORDERING INFORMATION

Part Number	Package	Marking	Supplying Form
UPG2214TB-E4-A	6-pin super minimold	G4J	<ul style="list-style-type: none"> <li>• Embossed tape 8 mm wide</li> <li>• Pin 4, 5, 6 face the perforation side of the tape</li> <li>• Qty 3 kpcs/reel</li> </ul>

**Remark** To order evaluation samples, contact your nearby sales office.  
 Part number for sample order: UPG2214TB-A

**Caution** Observe precautions when handling because these devices are sensitive to electrostatic discharge.

**PIN CONNECTIONS AND INTERNAL BLOCK DIAGRAM**

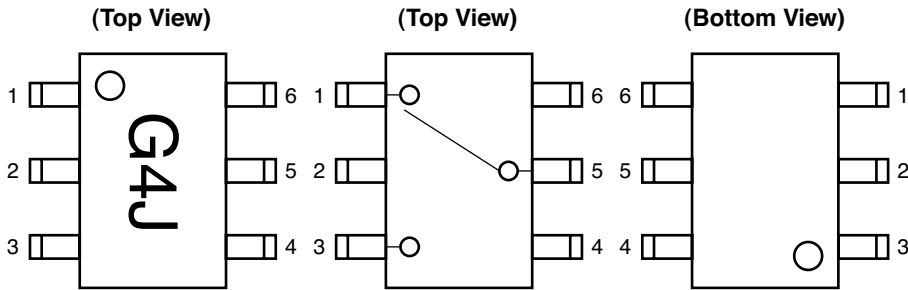

PIN NO.	PIN NAME
1	OUTPUT1
2	GND
3	OUTPUT2
4	V <sub>cont2</sub>
5	INPUT
6	V <sub>cont1</sub>

**TRUTH TABLE**

V <sub>cont1</sub>	V <sub>cont2</sub>	INPUT-OUTPUT1	INPUT-OUTPUT2
Low	High	ON	OFF
High	Low	OFF	ON

**ABSOLUTE MAXIMUM RATINGS** (T<sub>A</sub> = 25°C, unless otherwise specified)

PARAMETER	SYMBOL	RATINGS	UNIT
Switch Control Voltage	V <sub>cont</sub>	+6.0 <i>Note</i>	V
Input Power	P <sub>in</sub>	+30	dBm
Operating Ambient Temperature	T <sub>A</sub>	-45 to +85	°C
Storage Temperature	T <sub>stg</sub>	-55 to +150	°C

**Note** |V<sub>cont1</sub>-V<sub>cont2</sub>| ≤ 6.0 V

**RECOMMENDED OPERATING RANGE** (T<sub>A</sub> = 25°C, unless otherwise specified)

Parameter	Symbol	MIN.	TYP.	MAX.	Unit
Switch Control Voltage (H)	V <sub>cont(H)</sub>	1.8	3.0	5.3	V
Switch Control Voltage (L)	V <sub>cont(L)</sub>	-0.2	0	0.2	V

**ELECTRICAL CHARACTERISTICS**

(TA = +25°C, Vcont (H) = 3.0, Vcont (L) = 0 V, DC blocking capacitors value = 100 pF, unless otherwise specified)

PARAMETER	SYMBOL	TEST CONDITIONS	MIN.	TYP.	MAX.	UNIT
Insertion Loss 1	L <sub>ins1</sub>	f = 0.05 to 0.5 GHz <b>Note 1</b>	-	0.25	0.45	dB
Insertion Loss 2	L <sub>ins2</sub>	f = 0.5 to 1.0 GHz	-	0.25	0.45	dB
Insertion Loss 3	L <sub>ins3</sub>	f = 1.0 to 2.0 GHz	-	0.30	0.50	dB
Insertion Loss 4	L <sub>ins4</sub>	f = 2.0 to 2.5 GHz	-	0.35	0.55	dB
Insertion Loss 5	L <sub>ins5</sub>	f = 2.5 to 3.0 GHz	-	0.35	0.60	dB
Isolation 1	ISL1	f = 0.05 to 0.5 GHz <b>Note 1</b>	29	32	-	dB
Isolation 2	ISL2	f = 0.5 to 1.0 GHz	25	28	-	dB
Isolation 3	ISL3	f = 1.0 to 2.0 GHz	24	27	-	dB
Isolation 4	ISL4	f = 2.0 to 2.5 GHz	23	26	-	dB
Isolation 5	ISL5	f = 2.5 to 3.0 GHz	21	24	-	dB
Input Return Loss 1	RL <sub>in1</sub>	f = 0.05 to 0.5 GHz <b>Note 1</b>	15	20	-	dB
Input Return Loss 2	RL <sub>in2</sub>	f = 0.5 to 3.0 GHz	15	20	-	dB
Output Return Loss 1	RL <sub>out1</sub>	f = 0.05 to 0.5 GHz <b>Note 1</b>	15	20	-	dB
Output Return Loss 2	RL <sub>out2</sub>	f = 0.5 to 3.0 GHz	15	20	-	dB
0.1 dB Loss Compression Input Power <b>Note 2</b>	P <sub>in (0.1 dB)</sub>	f = 2.0/2.5 GHz	+21.0	+23.0	-	dBm
		f = 0.5 to 3.0 GHz	-	+23.0	-	dBm
1 dB Loss Compression Input Power <b>Note 3</b>	P <sub>in (1 dB)</sub>	f = 0.5 to 3.0 GHz	-	+27.0	-	dBm
2nd Harmonics	2f <sub>0</sub>	f = 2.0 GHz, P <sub>in</sub> = +15 dBm	-	-55	-47	dBc
		f = 2.5 GHz, P <sub>in</sub> = +15 dBm	-	-55	-47	dBc
3rd Harmonics	3f <sub>0</sub>	f = 2.0 GHz, P <sub>in</sub> = +15 dBm	-	-55	-47	dBc
		f = 2.5 GHz, P <sub>in</sub> = +15 dBm	-	-55	-47	dBc
Intermodulation Intercept Point	IIP <sub>3</sub>	f = 0.5 to 3.0 GHz, 2 tone, P <sub>in</sub> = +16 dBm, 5 MHz spicing	-	+58	-	dBm
Switch Control Current	I <sub>cont</sub>		-	4	20	μA
Switch Control Speed	t <sub>sw</sub>	50% CTL to 90/10% RF	-	20	200	ns

**Notes 1.** DC blocking capacitors = 1,000 pF at f = 0.05 to 0.5 GHz

**2.** P<sub>in (0.1 dB)</sub> is the measured input power level when the insertion loss increases 0.1 dB more than that of linear range.

**3.** P<sub>in (1 dB)</sub> is the measured input power level when the insertion loss increases 1 dB more than that of linear range.

**ELECTRICAL CHARACTERISTICS**(TA = +25°C, V<sub>cont</sub> (H) = 1.8, V<sub>cont</sub> (L) = 0 V, DC blocking capacitors value = 100 pF, unless otherwise specified)

PARAMETER	SYMBOL	TEST CONDITIONS	MIN.	TYP.	MAX.	UNIT
Insertion Loss 6	L <sub>ins6</sub>	f = 0.05 to 0.5 GHz <b>Note 1</b>	-	0.25	0.50	dB
Insertion Loss 7	L <sub>ins7</sub>	f = 0.5 to 1.0 GHz	-	0.25	0.50	dB
Insertion Loss 8	L <sub>ins8</sub>	f = 1.0 to 2.0 GHz	-	0.30	0.55	dB
Insertion Loss 9	L <sub>ins9</sub>	f = 2.0 to 2.5 GHz	-	0.35	0.60	dB
Insertion Loss 10	L <sub>ins10</sub>	f = 2.5 to 3.0 GHz	-	0.35	0.65	dB
Isolation 6	ISL6	f = 0.05 to 0.5 GHz <b>Note 1</b>	27	30	-	dB
Isolation 7	ISL7	f = 0.5 to 2.0 GHz	23	27	-	dB
Isolation 8	ISL8	f = 2.0 to 2.5 GHz	21	25	-	dB
Isolation 9	ISL9	f = 2.5 to 3.0 GHz	20	24	-	dB
Input Return Loss 3	RL <sub>in3</sub>	f = 0.05 to 3.0 GHz <b>Note 1</b>	15	20	-	dB
Output Return Loss 3	RL <sub>out3</sub>	f = 0.05 to 3.0 GHz <b>Note 1</b>	15	20	-	dB
0.1 dB Loss Compression	P <sub>in (0.1 dB)</sub>	f = 2.0/2.5 GHz	+14.0	+17.0	-	dBm
Input Power <b>Note 2</b>		f = 0.5 to 3.0 GHz	-	+17.0	-	dBm
1 dB Loss Compression Input Power <b>Note 3</b>	P <sub>in (1 dB)</sub>	f = 0.5 to 3.0 GHz	-	+20.0	-	dBm
Switch Control Current	I <sub>cont</sub>		-	4	20	μA
Switch Control Speed	t <sub>sw</sub>	50% CTL to 90/10% RF	-	20	200	ns

**Notes 1.** DC blocking capacitors = 1 000 pF at f = 0.05 to 0.5 GHz

2. P<sub>in (0.1 dB)</sub> is the measured input power level when the insertion loss increases 0.1 dB more than that of linear range.
3. P<sub>in (1 dB)</sub> is the measured input power level when the insertion loss increases 1 dB more than that of linear range.

**Caution** It is necessary to use DC blocking capacitors with this device.

The value of DC blocking capacitors should be chosen to accommodate the frequency of operation, bandwidth, switching speed and the condition with the actual board of your system. The range of recommended DC blocking capacitor value is less than 100 pF for frequencies above 0.5 GHz, and 1,000 pF for frequencies below 0.5 GHz.

EVALUATION CIRCUIT

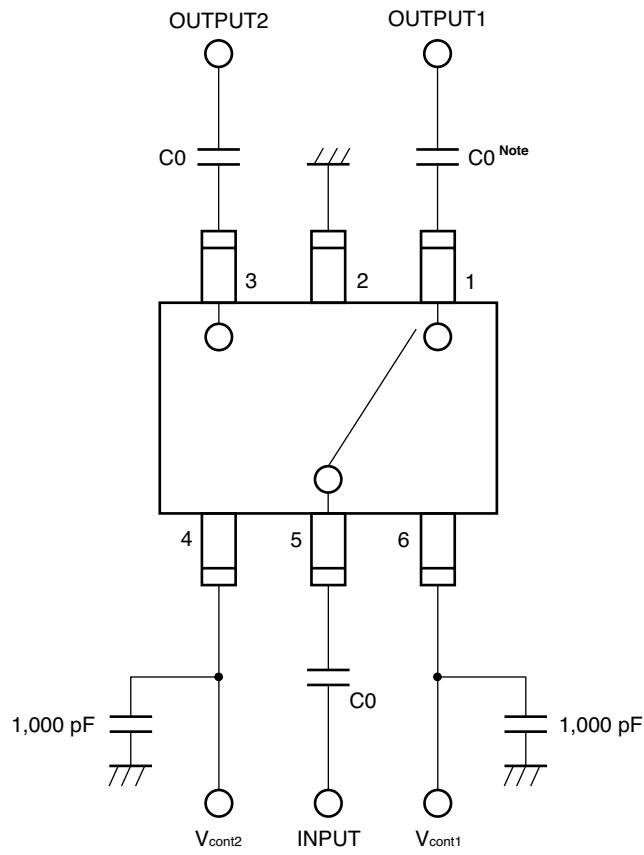

**Note** C0 : 0.05 to 0.5 GHz 1,000 pF  
: 0.5 to 3.0 GHz 100 pF

The application circuits and their parameters are for reference only and are not intended for actual design-ins.

ILLUSTRATION OF THE TEST CIRCUIT ASSEMBLED ON EVALUATION BOARD

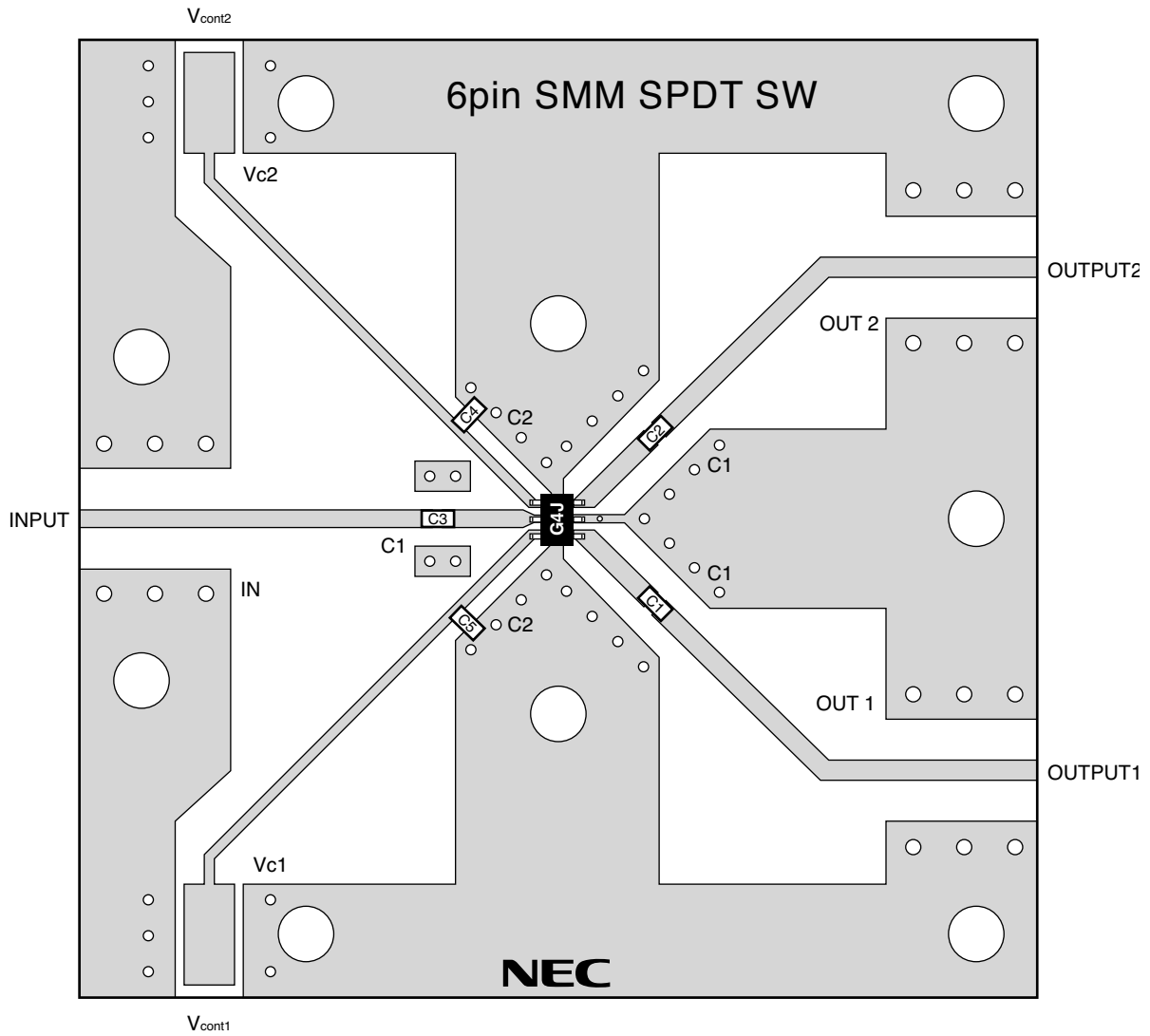

USING THE NEC EVALUATION BOARD

SYMBOL	VALUES
C1, C2, C3	100 pF
C4, C5	1,000 pF

**TYPICAL CHARACTERISTICS**

(TA = +25°C, Vcont (H) = 3.0 V, Vcont (L) = 0 V, DC blocking capacitors = 100 pF, unless otherwise specified)

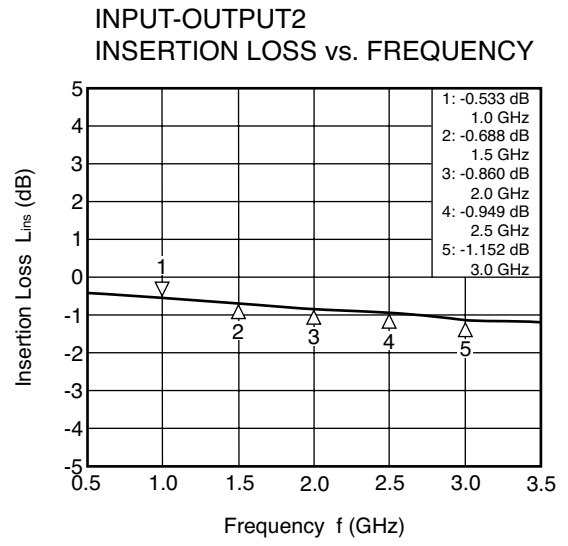
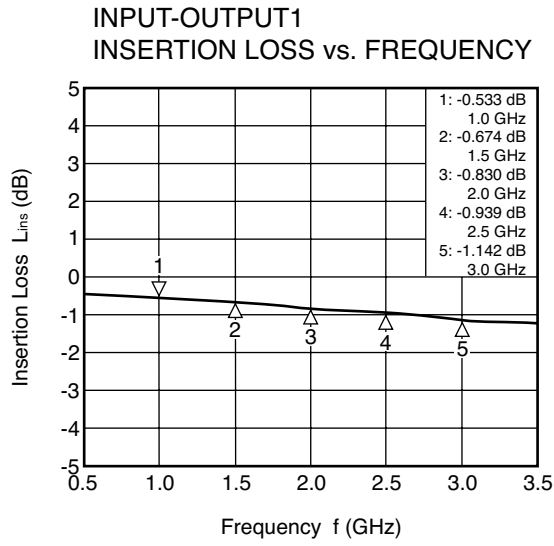

**Remark** The graphs indicate nominal characteristics.

**Caution** These characteristics values include the losses of the NEC evaluation board.

INPUT-OUTPUT1  
ISOLATION vs. FREQUENCY

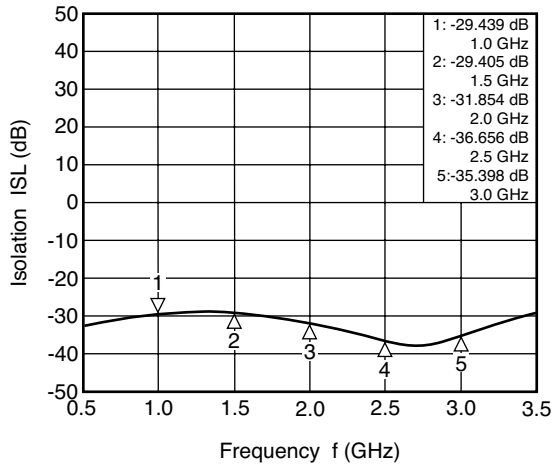

INPUT-OUTPUT2  
ISOLATION vs. FREQUENCY

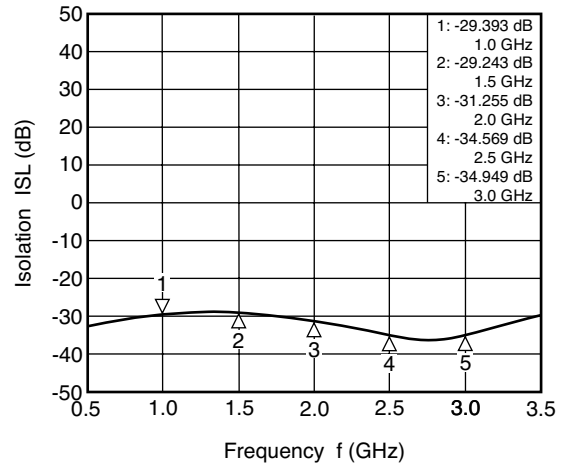

INPUT-OUTPUT1  
INPUT RETURN LOSS vs. FREQUENCY

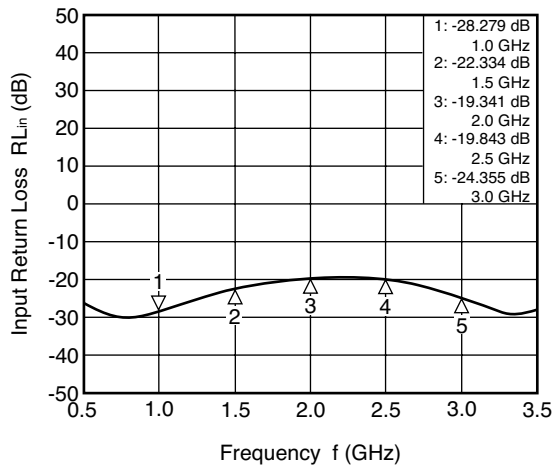

INPUT-OUTPUT2  
INPUT RETURN LOSS vs. FREQUENCY

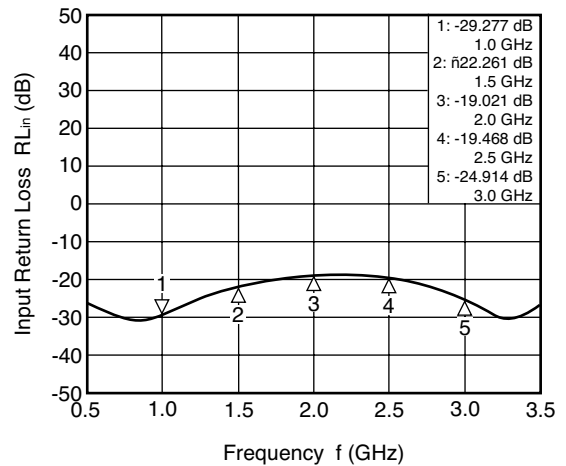

INPUT-OUTPUT1  
OUTPUT RETURN LOSS vs. FREQUENCY

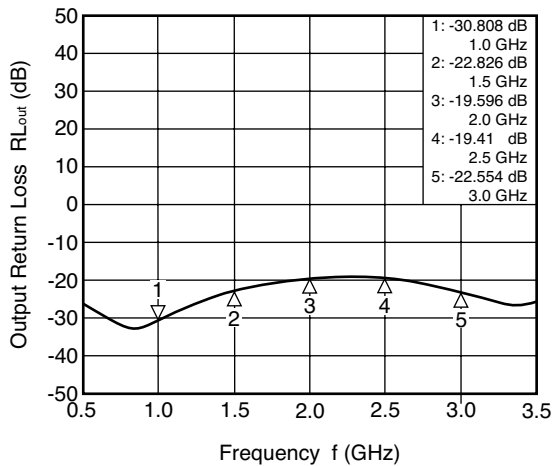

INPUT-OUTPUT2  
OUTPUT RETURN LOSS vs. FREQUENCY

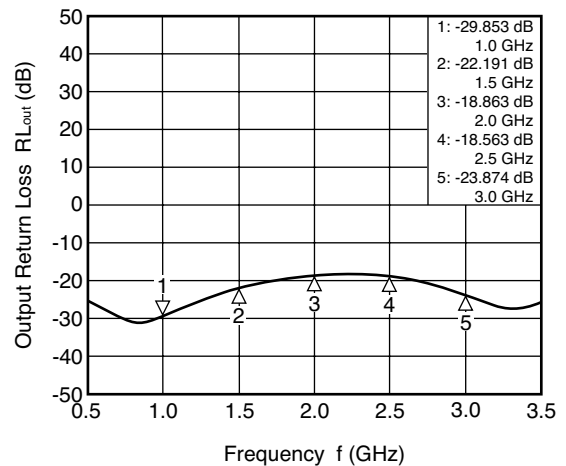

**Remark** The graphs indicate nominal characteristics.



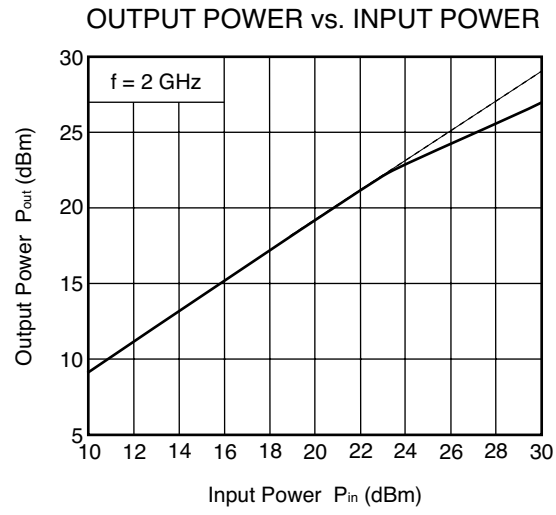

**Remark** The graphs indicate nominal characteristics.

**PACKAGE DIMENSIONS**

6-PIN SUPER MINIMOLD (UNIT: mm)

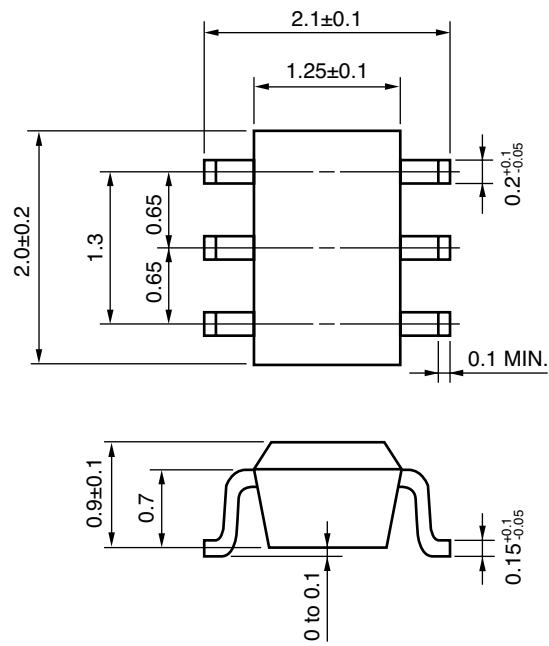

## RECOMMENDED SOLDERING CONDITIONS

This product should be soldered and mounted under the following recommended conditions. For soldering methods and conditions other than those recommended below, contact your nearby sales office.

Soldering Method	Soldering Conditions	Condition Symbol
Infrared Reflow	Peak temperature (package surface temperature) : 260°C or below Time at peak temperature : 10 seconds or less Time at temperature of 220°C or higher : 60 seconds or less Preheating time at 120 to 180°C : 120±30 seconds Maximum number of reflow processes : 3 times Maximum chlorine content of rosin flux (% mass) : 0.2%(Wt.) or below	IR260
VPS	Peak temperature (package surface temperature) : 215°C or below Time at temperature of 200°C or higher : 25 to 40 seconds Preheating time at 120 to 150°C : 30 to 60 seconds Maximum number of reflow processes : 3 times Maximum chlorine content of rosin flux (% mass) : 0.2%(Wt.) or below	VP215
Wave Soldering	Peak temperature (molten solder temperature) : 260°C or below Time at peak temperature : 10 seconds or less Preheating temperature (package surface temperature) : 120°C or below Maximum number of flow processes : 1 time Maximum chlorine content of rosin flux (% mass) : 0.2%(Wt.) or below	WS260
Partial Heating	Peak temperature (pin temperature) : 350°C or below Soldering time (per side of device) : 3 seconds or less Maximum chlorine content of rosin flux (% mass) : 0.2%(Wt.) or below	HS350

**Caution** Do not use different soldering methods together (except for partial heating).

### Life Support Applications

These NEC products are not intended for use in life support devices, appliances, or systems where the malfunction of these products can reasonably be expected to result in personal injury. The customers of CEL using or selling these products for use in such applications do so at their own risk and agree to fully indemnify CEL for all damages resulting from such improper use or sale.

**CEL** California Eastern Laboratories, Your source for NEC RF, Microwave, Optoelectronic, and Fiber Optic Semiconductor Devices.

4590 Patrick Henry Drive • Santa Clara, CA 95054-1817 • (408) 988-3500 • FAX (408) 988-0279 • [www.cel.com](http://www.cel.com)

DATA SUBJECT TO CHANGE WITHOUT NOTICE

12/16/2004

Subject: Compliance with EU Directives

CEL certifies, to its knowledge, that semiconductor and laser products detailed below are compliant with the requirements of European Union (EU) Directive 2002/95/EC Restriction on Use of Hazardous Substances in electrical and electronic equipment (RoHS) and the requirements of EU Directive 2003/11/EC Restriction on Penta and Octa BDE.

CEL Pb-free products have the same base part number with a suffix added. The suffix –A indicates that the device is Pb-free. The –AZ suffix is used to designate devices containing Pb which are exempted from the requirement of RoHS directive (\*). In all cases the devices have Pb-free terminals. All devices with these suffixes meet the requirements of the RoHS directive.

This status is based on CEL’s understanding of the EU Directives and knowledge of the materials that go into its products as of the date of disclosure of this information.

Restricted Substance per RoHS	Concentration Limit per RoHS (values are not yet fixed)	Concentration contained in CEL devices	
		-A	-AZ
Lead (Pb)	< 1000 PPM	Not Detected	(*)
Mercury	< 1000 PPM	Not Detected	
Cadmium	< 100 PPM	Not Detected	
Hexavalent Chromium	< 1000 PPM	Not Detected	
PBB	< 1000 PPM	Not Detected	
PBDE	< 1000 PPM	Not Detected	

If you should have any additional questions regarding our devices and compliance to environmental standards, please do not hesitate to contact your local representative.

Important Information and Disclaimer: Information provided by CEL on its website or in other communications concerning the substance content of its products represents knowledge and belief as of the date that it is provided. CEL bases its knowledge and belief on information provided by third parties and makes no representation or warranty as to the accuracy of such information. Efforts are underway to better integrate information from third parties. CEL has taken and continues to take reasonable steps to provide representative and accurate information but may not have conducted destructive testing or chemical analysis on incoming materials and chemicals. CEL and CEL suppliers consider certain information to be proprietary, and thus CAS numbers and other limited information may not be available for release.

In no event shall CEL’s liability arising out of such information exceed the total purchase price of the CEL part(s) at issue sold by CEL to customer on an annual basis.

See CEL Terms and Conditions for additional clarification of warranties and liability.